

Viimeisin kampanjatiedotteemme on ilmestynyt 10.6.19, kts tarkemmat tiedot **KAMPANJA**-linkistä!

SOFTA SUPERSTORE WWW.SOFTASUPERSTORE.COM WWW.OHJELMISTOT.FI 30.07.2019 • v17 • 12:37	Asiakaspalvelu ark. 10.30 - 16 09 - 3424 370	TUOTEHAKU Tarkennettu haku	TUOTERYHMÄT HAE -- Valitse -- Powered by DataCenter Finland Oy	KIRJAUDU OSTOSKORI
--	--	---	--	-------------------------------------

PÄÄVALIKKO

ETUSIVU
YRITYSTIEDOT
TUOTEPERHEET
TUOTERYHMÄT
SUPERHAKU
LISENSSIT
KAMPANJA
UUTUUDET
SUPERTARJOUKSET
SOFTABASAARI
SOFTAINFOA
Softautiset.
Käytetyt lyhenteet.
Tuote-esittelyjä.
Juridiikka.
Tietoturvaongelmien ratkaisuja.
Ohjelmistovalmistajien tukea.
Käyttäjäfoorumeja.
Hyödyllisiä apuohjelmia.
Softademo-linkkejä.
Lehdistölinkkejä.
Lehdistötiedotteita.
Seminaarikutsuja.
Asennusapua
Kaikenkattavat IT-palvelut
Muuta mielenkiintoista.
Vendors only!
Omat kotisivut

TILAUSOHJEET
POSTITUSLISTA
REKISTERÖINTI
PIKAHINNASTO
TARJOUSPYYNTÖ
PALAUTE
ATK-KAAPELIT
ATK-KIRJAT
ATK-LEHDET

ACD Systems Canvas 15

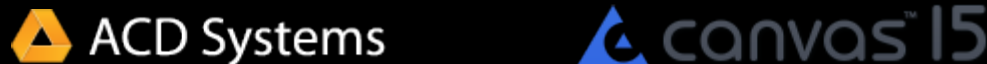

ACD Systems is one of the largest and most respected independent digital image editing and management companies in the world. The company was founded in 1993 in Texas by technology and imaging visionary Doug Vandekerkhove. Doug foresaw the importance of the convergence of analog and digital (print, photos, scans, video and metadata) in the 80's, revolutionizing how analog and digital information was used in pre-Web applications. Today ACD holds seven patents, and millions of ACDSsee products are in use throughout the world.

ACD Systems has offices in the United States and Canada, supported by a team of global channel partners. With a product family that includes includes ACDSsee Pro 6, ACDSsee Pro 2 (Mac), ACDSsee 15 photo editing and management solutions, and Canvas technical illustration software, the company serves millions of consumers, small and medium sized businesses, government agencies and educational institutions, and corporate customers.

Representative markets for ACD Systems' products include AEC (architecture, engineering and construction), insurance, manufacturing, aerospace, automotive, government, architecture/construction, education, gaming, technology, bio/health and oil/gas/energy. Customers include General Motors, Caterpillar, Boeing, The New York City Fire Department, NASA, CNN and the Royal Canadian Mounted Police. ACDSsee software was used in the making of the movie Titanic because the filmmakers recognized that only ACDSsee could provide the illustration, editing and management tools required for their large scale, complex development tasks and image management requirements.



Why Canvas 15?

Analyze, enhance, and share your rich information with ease, precision, and professional results, all while utilizing just one integrated application.



Canvas 15 is all you need.

Canvas allows engineers and technical graphics professionals to illustrate and communicate with confidence. Canvas' minimum precision levels and powerful object illustration and image editing tools ensure that the accuracy of your data is maintained right through to publication. Accelerate and streamline your technical illustration workflow from initial import and design to final presentation, facilitate collaboration, and improve your overall productivity with this complete technical illustration software solution.

What's New in Canvas 15

With advanced interpolation methods for rendering and resampling images, a brand new color management engine, improved support for digital camera RAW files and camera models, and a host of efficiency-driven advancements to make your life easier, designing and sharing your technical graphics vision has never been this painless. Or this snappy.

Work Your Way

Canvas now supports your personal workflow preferences, including the ability to save your customized layout and have it open as you like it each time you start the application. Avoid wasting time with the Previous View command, designed to allow you to conveniently return to your previous magnification level and position in the document. And it is now possible to open each of your projects in a new application window, allowing for simple comparing and contrasting, or multitasking.

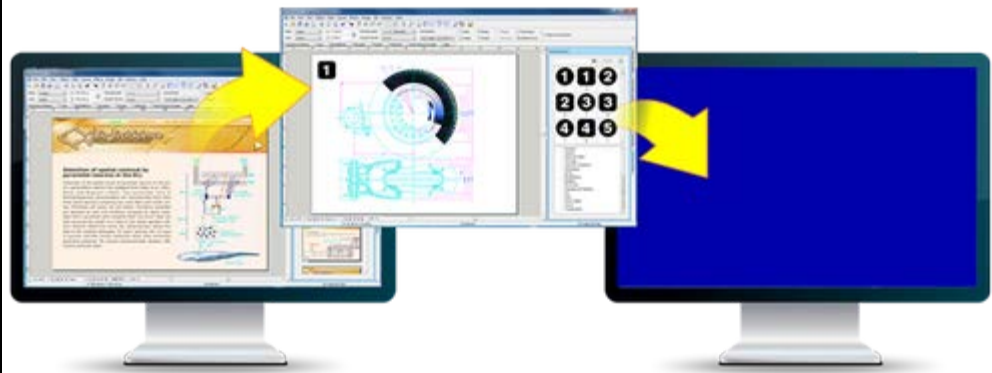

Effortless Precision

Use the Smart Mouse and Guides to precisely snap lines to objects and manage complex angles and distances. Take the guesswork out of centering, dividing, and snapping to corners of geometric shapes and aligning lines at sensitive angles with these sophisticated guidance tools.

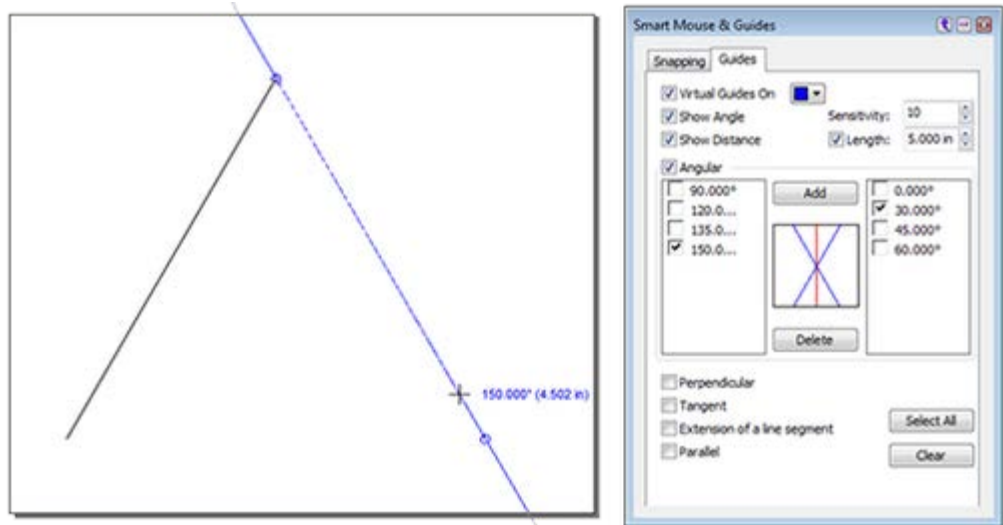

Carefree Copying

Quickly unify the elements of your project by using the Attribute Dropper tool to copy the attributes of one vector object to another. This feature makes it easy to maintain the consistency of aspects like stroke, pen, fill ink, text style, transform, dimensions, transparency, and more.

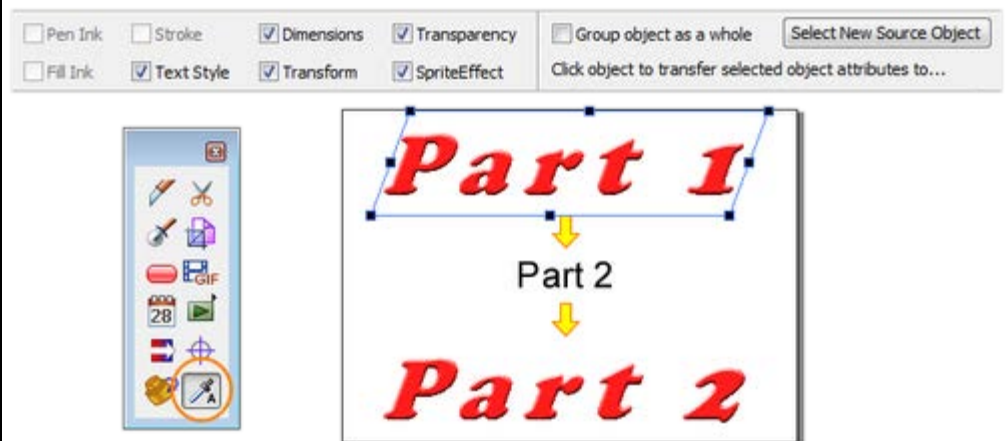

Tightened Text Workflow

Diversify your projects with quick, hassle-free access to special characters. Speed up your editing process with the ability to merge multiple text boxes, including merging all the boxes on the page, or simply a selection.

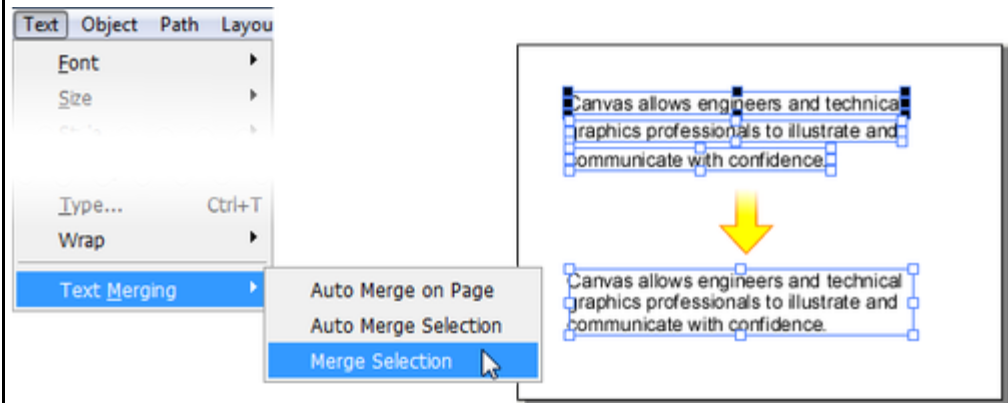

An Expanded Library

Canvas 15 comes packed with additional symbol and clip art libraries perfect for a diverse range of tasks, from crime scene labeling and furniture layout, to circuit board design and energy exploration.

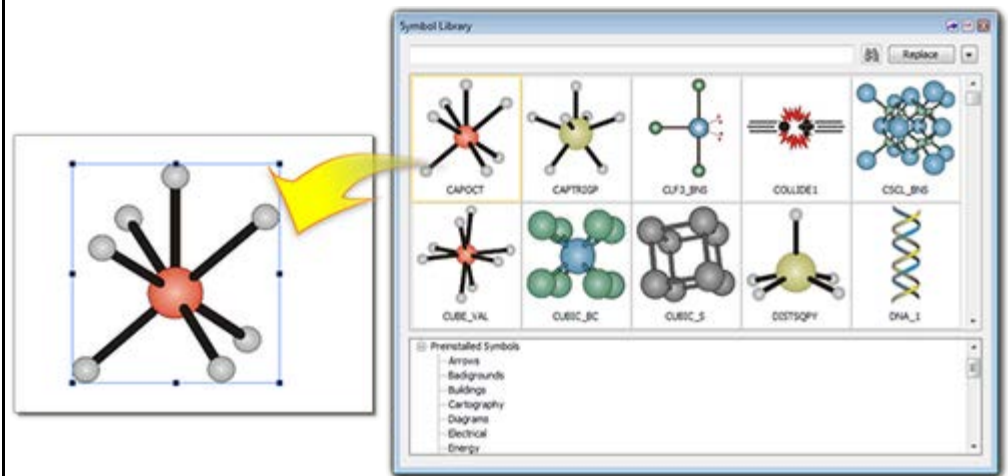

Streamline Your Sophisticated Shapes

Maximize efficiency with the ability to set objects to flip as they replicate. Create and edit polygons the way you want, with locked lengths and specified alternate angles.

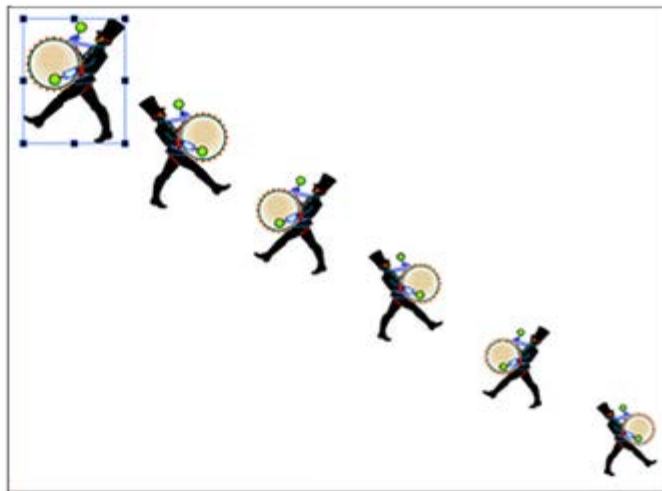

Accelerate Your AutoCAD Project

Experience greater flexibility with the option to customize the drawing scale of AutoCAD DWG and DXF file formats. Canvas 15 will also substitute the CAD user data interchange standard fonts for easy editing and accessibility.

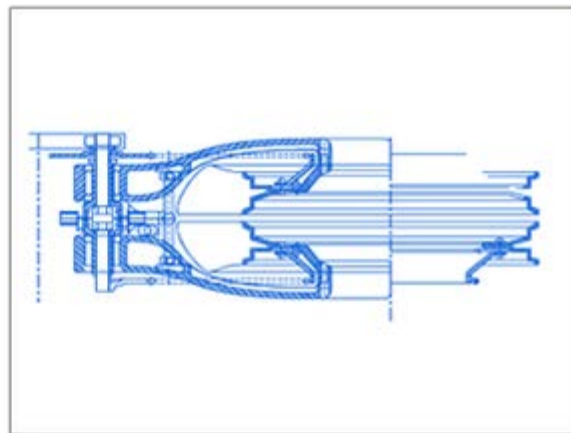
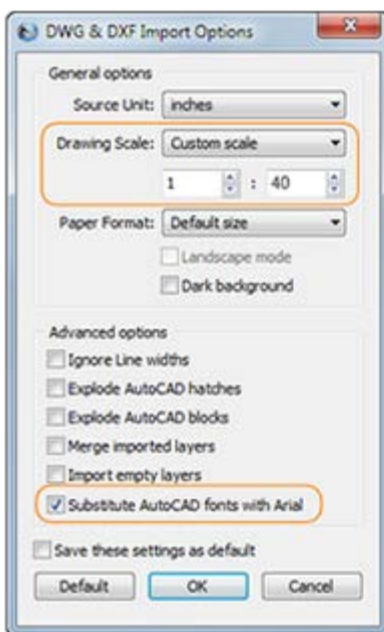

Fly to the Web

Canvas 15 now supports the importing and exporting of WebP, a format designed to allow lossless and lossy compression for images being uploaded to the web.

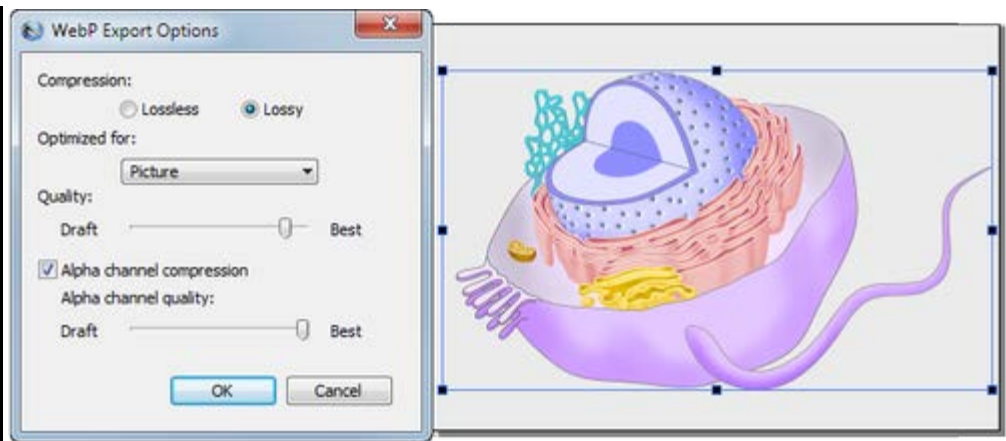

Create Powerful PDFs

With Canvas 15's overhauled PDF export dialog, enjoy more versatile, robust PDFs, accommodating better export compression, support for grayscale color mode, layer-based transparent effects rendering, the ability to export object properties, and more. Importing PDFs has also been improved to make life easier, including text and image merge support.

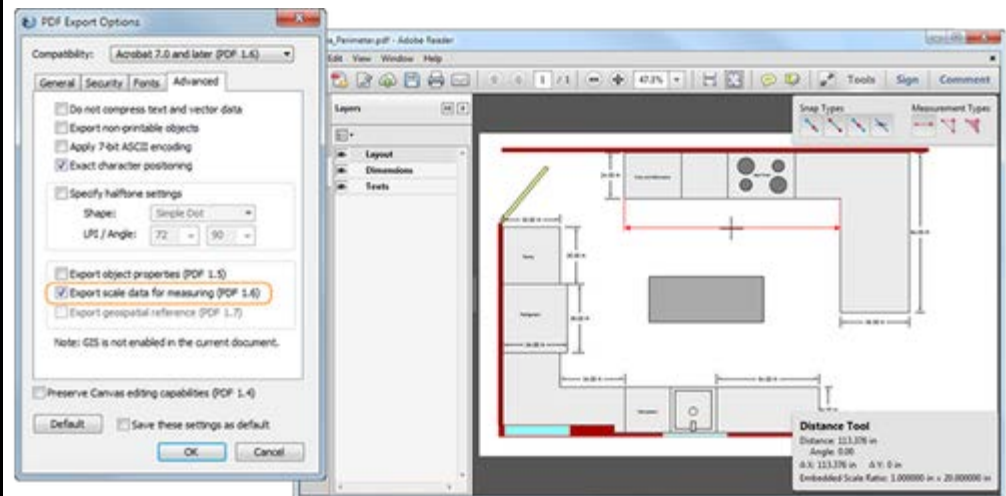

More GIS Data Solutions

With an ever-expanding range of handled file formats and information analysis tools, Canvas GIS users are better supported than ever with the ability to import, modify, and export Google Earth™ KMLs and KMZs. Create buffers for objects that are tagged Point, Line, or Area for greater visualization and map utilization. Simplify your communications with the ability to export layered PDFs with geospatial information embedded and viewable with Acrobat Reader XI™. Open, place, or import formats used by GPS-aware devices, satellite imaging systems, or digital elevation models, such as GPX or Geo JPEG 2000.

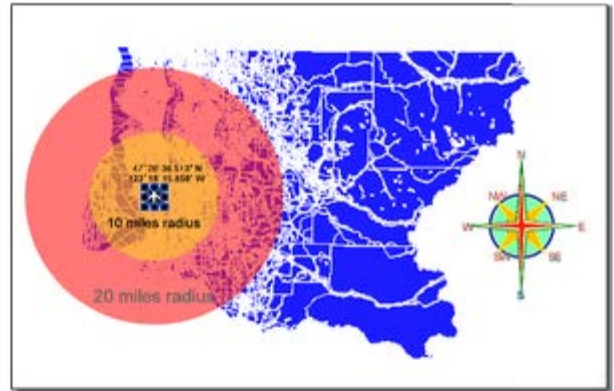
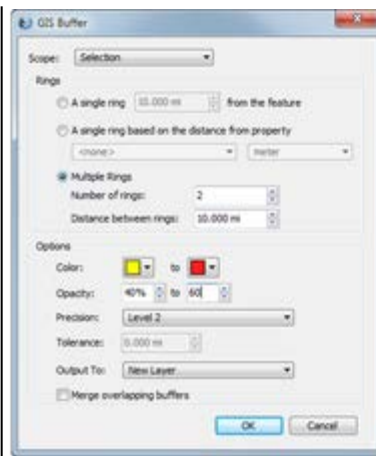

Your Complete GIS Data Solution

Canvas 15 with the optional GIS module offers a powerful set of GIS-based features and commands that support a range of GIS formats, define complex map projections, and perform advanced property operations. It's an indispensable tool for GIS professionals in the oil & gas and energy sectors, aerospace and automotive industries, education, and government.

Streamline Your Workflow

Canvas 15 + GIS can handle all your GIS data needs. Import the following GIS specialized file formats:

- TIFF (GeoTIFF TIFF/World File image, + pixel scale info. & location, in real world coordinates)
- SHP (Shapefile)
- E00 (ARC/INFO interchange)
- RT1 (Tiger, Topologically Integrated Geographic Encoding and Referencing)
- SDTS (USGS Spatial Data Transfer Standard)
- MIF (Mapinfo Data Interchange)
- S57 (International Hydrographic Organization)
- ECW (Enhanced Compressed Wavelet images)
- SID (MrSID)
- GML (Geography Markup Language)
- Geo JPEG
- Geo JPEG 2000
- Geo BMP (BMP + projection info.)
- Geo PNG (PNG + projection info.)
- Geo GIF (GIF + projection info.)
- GIS Text (TXT file with GIS data)
- GPS Garmin (TXT file containing GPS Garmin data)
- DOQ/NES/SES/NWS/SWS (USGS Digital Orthoquad Files)
- DLG/DO/OPT (DLG-O files)
- GPX (GPS exchange)
- KML/KMZ

Canvas 15 with GIS also supports export to these GIS specialized formats: TIFF, SHP, KML, KMZ, ECW, Geo JPEG, Geo JPEG 2000, Geo BMP, Geo PNG, Geo

GIF, Geospatial PDF, and GIS Text.

Create with Precision

GIS Manager

Within Canvas' GIS Manager you can choose settings to define geo-referencing information for a new document, or re-set the projection of an open document. GIS Manager options include Projection, Geo CS, Angular Units, Linear Units, Axis Orientation, and the Auto Define Document Coordinate system dialog.



GIS Positioning Palette

Strategically move or position objects according to their latitude and longitude coordinates while displaying the Length and Forward Azimuth when measuring between two points, and the percentage of error. Measure distance in world coordinates by drawing and selecting a line between two points.

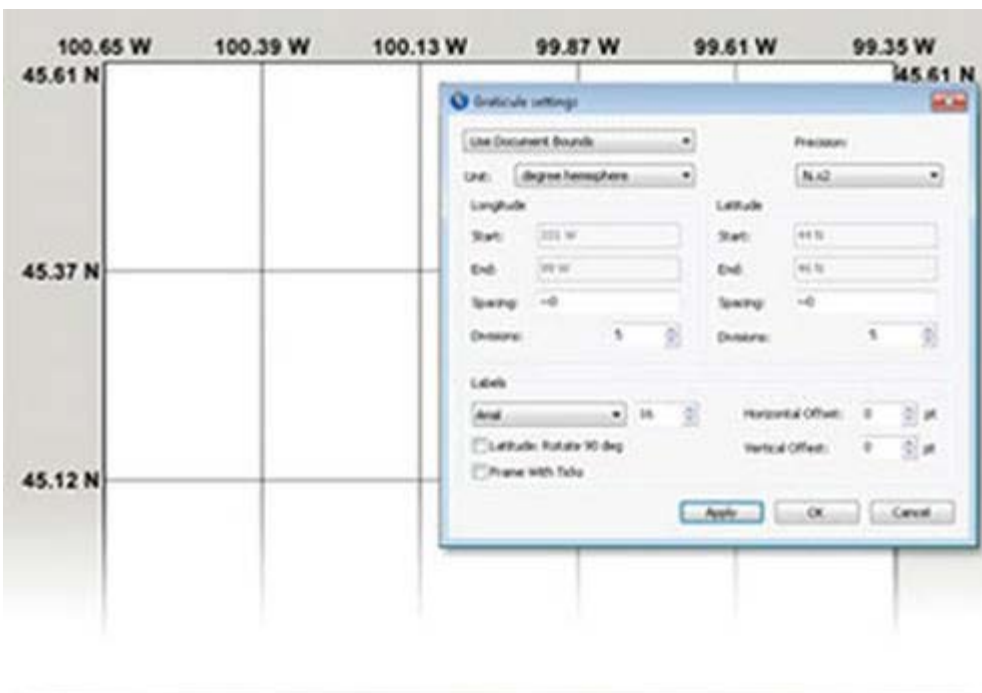

Replicate and Position Dialog

Create object replicates and precisely place them according to latitude and longitude.

Graticule Dialog

Create a grid of lines that displays meridians of longitude and parallels of latitude, while precisely controlling its units of measure, precision decimal levels, longitude, latitude, start/end points, spacing/divisions, latitude degree rotation, horizontal and vertical offsets, and even the label format settings.

Edit Geographic Coordinate System Dialog

Define a geographic coordinate system for a projection, and modify it with options such as Geo CS name, Ellipsoid, Prime Meridian, and Datum Transformation.

PointtoPoint command

Georegister a GIS drawing to the geographic location of a "known good" reference image.

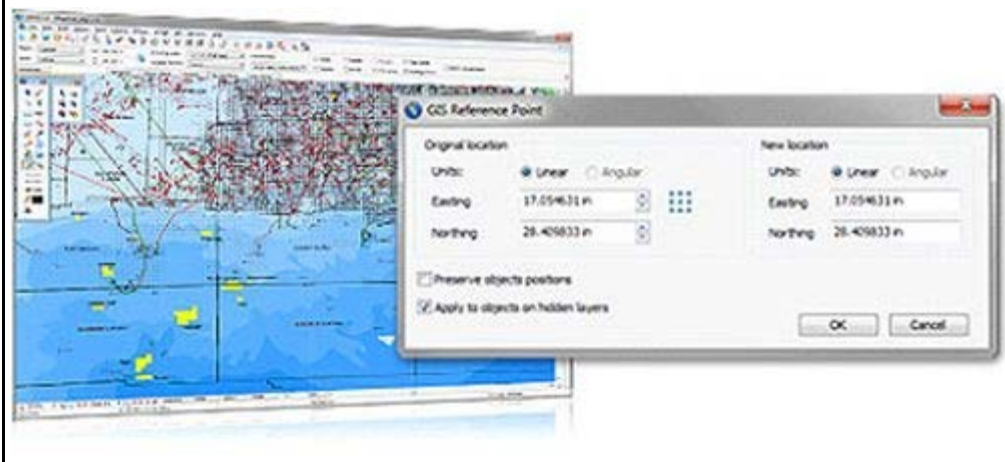

Auto Define Document Coordinate System

Set your GIS drawing scale and reference point, and define a reference rectangle. Based on the selected point or defined bounding box, Canvas then automatically sets up the projected coordinate system for that file.

Visualize and Enhance

The Select by Property interface lets you create a project-specific customized query based upon unique properties, values, or other related criteria. Edit your query to meet new project needs, save for ongoing use, or share with colleagues.

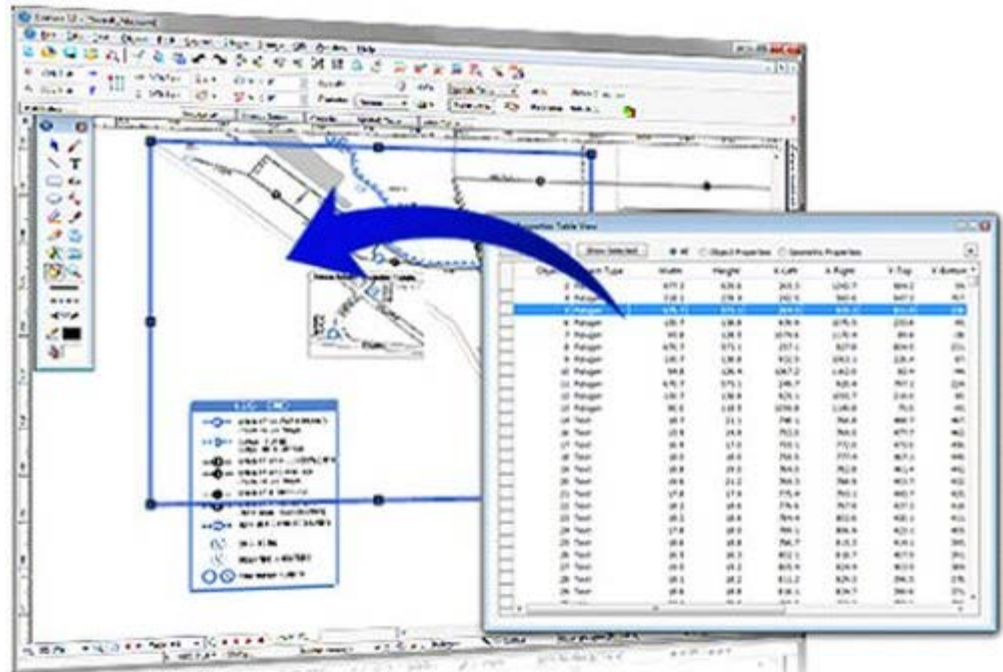

Object Properties

View, numerically edit, and reapply map attributes that have been assigned to map objects via the Object Properties Table View command.

Buffer Objects

Create buffers for objects that are tagged Point, Line, or Area for greater visualization and map utilization.

Label by Property

Perform a query and assign text labels to map objects with defined settings such as text format, location, and rotation angle. You can also apply or adjust collision detection settings.

Visualize Data

Access many of the very detailed fill, stroke, ink, and GIS-specialized augmentation options required by GIS data visualization. Modify the appearance of map objects

according to a selected property or a query to create thematic and choropleth maps.

Statistics by Property

View complete information regarding the total number of map objects on a layer or within a selection.

Symbol Library Palette and Visualize Data Command

Enhance map symbols to increase visual appeal and dynamically replace them at any time to ensure project consistency through the Symbol Library palette and Visualize Data command.



Image Warp and Coordinates Commands

Quickly, yet precisely, warp GIS illustrations with the Image Warp command. Or use the Coordinates command to place control points within a selected image and warp it according to these points.

System Requirements

Hardware

- Intel® Pentium® 4 or better
- 512 MB RAM (1 GB RAM recommended)
- 950 MB free hard drive space (1.5 GB recommended)
- 16-bit color or higher (True color recommended)
- 1024x768 or higher screen resolution recommended
- DVD drive – to install from the installer



disk

Software

- Microsoft® Windows® XP with Service Pack 3, Windows Vista®, Windows® 7 or Windows® 8.
- Microsoft® Internet Explorer® 7 or Higher



 **EARN UP TO €100* CASHBACK** **Create and Save**  **CoreIDRAW GRAPHICS SUITE 2019**  *Terms and conditions apply. Payment in local currency. [FIND OUT MORE](#)



KESKITETYSTI



KESKITETYSTI